

Service Data

Vickers®

Directional Controls



Wet Armature Directional Control Valves

DG4S*-01*A/F-(U)-*-60

COIL S/A	COIL KIT	VOLTAGE		DC VOLT	COIL CODE	DIN COIL-KIT	DIN COIL S/A
		60 HZ	50 HZ				
868982	892995	120	110		B	893007	879141
868983	892996	240	220		D	893008	879143
868984	892997	460	440		M	893009	879231
868985	892998		127		EG	893010	879232
879211			240		ED		879142
879212			110		A		879144
879213			220		C		879227
879214			24		NN		879228
879215	893003	100	100		T	893015	879229
879216	893004	380	380		DZ	893016	879230
02-101843		24	24		N		02-101845
02-101976		200	200		OV		02-127060
868987	892999			12	G	893011	879146
868988	893000			24	H	893012	879147
868986	893001			48	J	893013	879148
868990				110	P		879226
868991				100	R		879225
868992	893002			250	X	893014	879224
879233				125	DP		879149
02-119664		48	48		K		02-127061
02-119665			48		KK		02-127062
02-119666		24			NV		02-127063
02-300515		220			DN		02-300519
02-300516		115			EK		02-300520
02-300517		110	100		BX		02-300521
02-300518		320	200		DX		02-300522

MODEL	PART NO.	SPOOL KIT
DG4S2-012A-(RH)	573396	893200
DG4S2-012A-(LH)	573396	893201
DG4S4-010A-(RH)	572287	893202
DG4S4-010A-(LH)	572287	893203
DG4S4-012A-(RH)	463426	893204
DG4S4-012A-(LH)	463426	893205
DG4S4-016A-(RH)	572288	893206
DG4S4-016A-(LH)	572288	893207
DG4S4-017A-(RH/LH)	502121	893208
DG4S4-010F-(RH/LH)	572287	893143
DG4S4-011F-(RH/LH)	868617	893144
DG4S4-012F-(RH/LH)	463426	893145
DG4S4-013F-(RH/LH)	477155	893146
DG4S4-016F-(RH/LH)	572288	893147
DG4S4-017F-(RH/LH)	502121	893148

DIN Coil Mating Receptacle

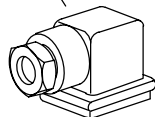

DIN Coil (See Table)

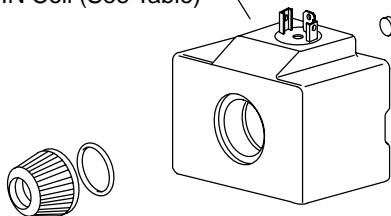

879209 Plug (2 Req'd)

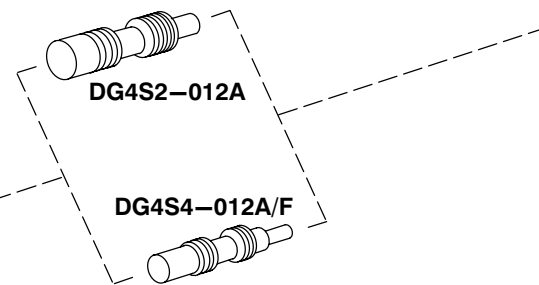
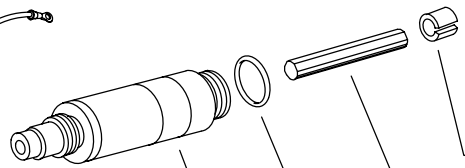
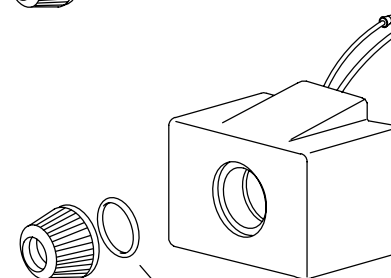

868953 Stop

02-153961 Push Pin (A)

02-140344 Push Pin (F)

262338 "O" Ring

Core Tube S/A

AC - 02-153967

DC - 879169

■ Coil (See Table)

▲■◆ 187000 "O" Ring

879172 Knob

DC Coils with Surge Suppression Device Encapsulated

Coil S/A	DC Voltage	DIN Coil S/A	Coil Code
02-154795	12	02-154798	G
02-154767	24	02-154796	H

Refer to model code for ordering with surge suppression.

MODEL	DIAGRAM PLATE
DG4S2-012A	290347 (R.H.) 577488 (L.H.)
DG4S4-01*A	290348 (R.H.) 577490 (L.H.)
TYPE 7 SPOOL	290339 (R.H./L.H.)
DG4S4-01*F	290339

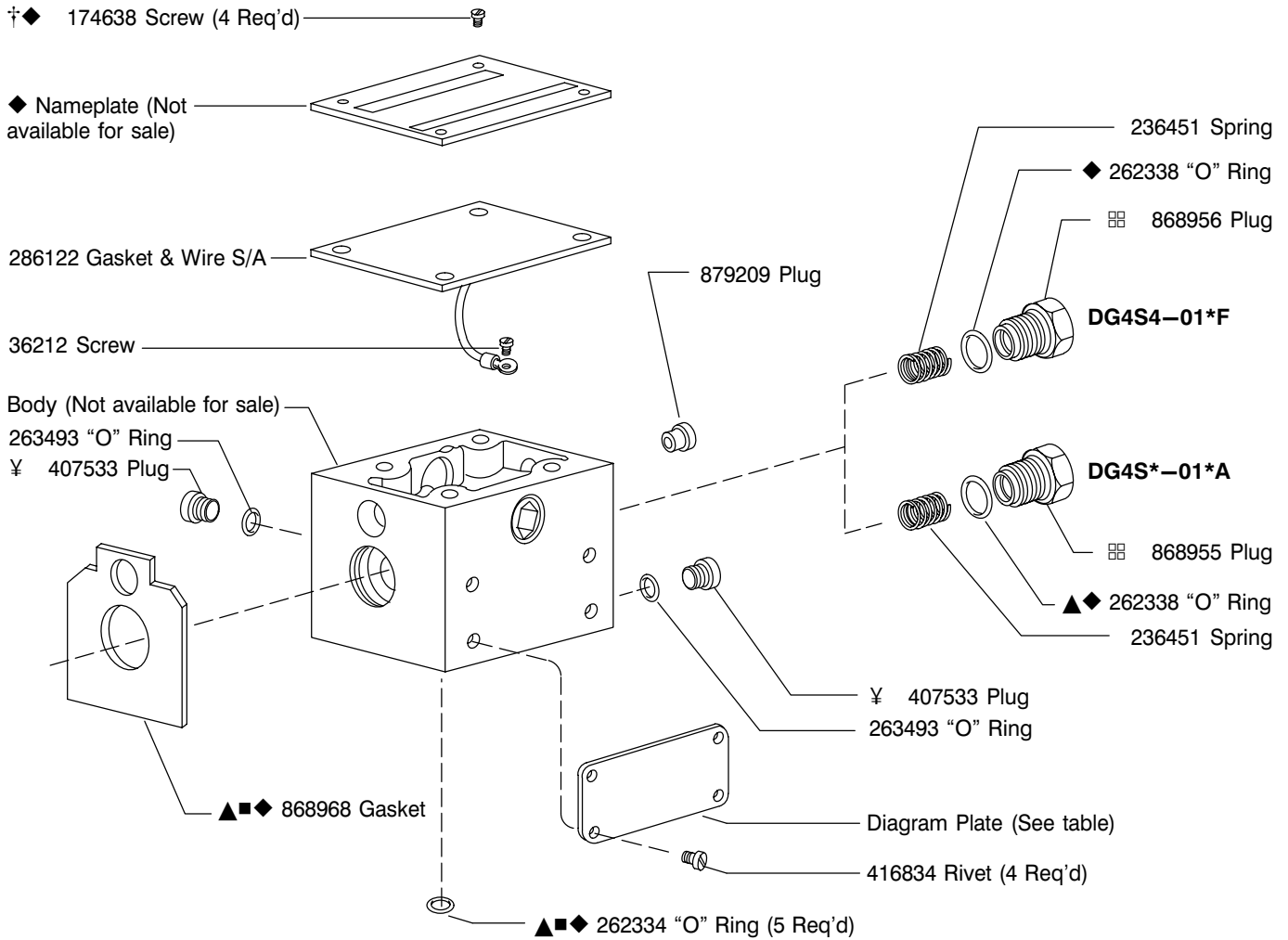

Note

Right hand assembly shown. For left hand assembly (-LH models), all parts of valve except body are reversed. Use left hand diagram plate.

Note

Parts numbers prefixed with symbols available only in kits.

Note

For satisfactory service life of these components in industrial applications, use full flow filtration to provide fluid which meets ISO cleanliness code 18/15 or cleaner.

- ▲ Included in F3 Seal Kit 892976
- ◇ Included in Fastener Kit 893005
- ◆ Included in Spool Kit
- Included in Coil Kit
- 868955 Torque 24-29 N.m (18-22 lbf. ft.)
- ¥ Torque 12.1-12.4 N.m (107-110 lbf. in.)
- † Torque 0.8-1.01 N.m (7-9 lbf. in.)

Model Code

(F3) D G 4 S 4 ** - 01 * A - (U) * - * - 60 - (LH)

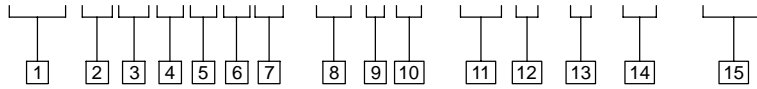

1 Special Seals

Blank - Standard seals
F3 - Special seals

2 Directional Control Valve

3 Manifold or Subplate Mounted

4 Solenoid Operated

5 Sliding Spool

6 Flow Direction

2 - Two way
4 - Four way

7 Electrical Accessories

L - Solenoid indicator lights
W - Wiring housing
LW - Wiring housing with indicator lights
WT - Wiring housing with terminal strip

8 Interface

01 - ISO-4401-AC-50-4-A NFPA D05
 (1/8 in. nominal size)

9 Spool Types

"A" Models - 0, 2, 6, 7, & 2-way
 "B" Models - 0, 1, 2, 3, 6 & 7

10 Spool/Spring Arrangement

A - Spring offset P to A
F - Spring offset P to A; shift to center

11 Wet Armature Solenoid

(non-serviceable core tubes)

Blank - Flying lead coils

U - DIN 43650 coils w/o electrical plug

12 Coil Type

7 - Coil with surge suppression
 (DC models only 12 & 24V DC)

13 Coil Identification Letters

14 Design

15 Left-Hand Assembly

(omit for right-hand assembly)

Light Kits

Solenoid Indicator Light Kit
 (Includes all parts identified)

Voltage Range	Kit
100 thru 127	941615
192 thru 233	941617

